

SOLEAL

UNIVERSAL SLIDER



Architect: RIVA Architectes
Photography: DR RIVA Architectes

IMAGINE WHAT'S NEXT

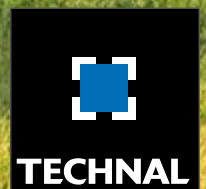



Architect: Architecture agency FRANCK MARTINEZ
Photographer: Franck Martinez

SOLEAL SLIDER

/ A BENCHMARK PRODUCT FOR ANY PROJECT

A NEW GENERATION OF SLIDERS

The SOLEAL slider's intrinsic qualities make it a new benchmark product on the market thanks to its many applications and options.

Whether it's a new build or renovation, from the simplest to the most complex project, the SOLEAL slider offers a suitable solution every time.

A BROAD EVOLVING RANGE

The SOLEAL range is available in many applications: 2 to 4 tracks, from sliding-sash pocket window to 3-track composite pocket window frames, internal or external corner solution, composite frames. All applications are available with concealed drainage and with or without a disabled access threshold.

The SOLEAL slider is based on a 55 mm module with a 20 mm thermal break and on a 65 mm module with a 30 mm thermal break. The installation and cladding environments are the same as for SOLEAL casements and doors.

A straight cut or monobloc SOLEAL 65 version is also available. Dedicated to new projects or for mass-production, this offer combines thin lines of aluminium frames and a high thermal performance.



Architect: Anthony Vienne

SOLEAL

/ REFINED AESTHETIC DESIGN

STRAIGHT, MODERN LINES

- Detailed design allowing concealed drainage for all applications
- Minimalist-style strip reinforcers: may be enhanced with a decorative profile (Technal patent) in polished anodised finish



Ext. detail: lower section concealed drainage



Decorative profile: reinforcer

LOCKING MECHANISMS

A variety of locking options available, from 1 to 4 locking points, with or without locking

* Technal exclusive design



Pull handle on service opening sash



Thumb pull on semi-fixed opening sash



Straight handle on service opening sash



Pull handle for strip reinforced mullion



Same handle for both window and door



Stainless steel handle

SOLEAL

/ ACCESSIBILITY AND COMFORT

ACCESSIBILITY THRESHOLD

All SOLEAL sliding patio doors satisfy French law no. 2005-102:11/02/2005 for building accessibility. An addition to the frame, comprising an (external) access ramp and a special heat shield (between tracks), enables a disabled access.

This option can be provided for new build or renovation work, in all SOLEAL slider applications.

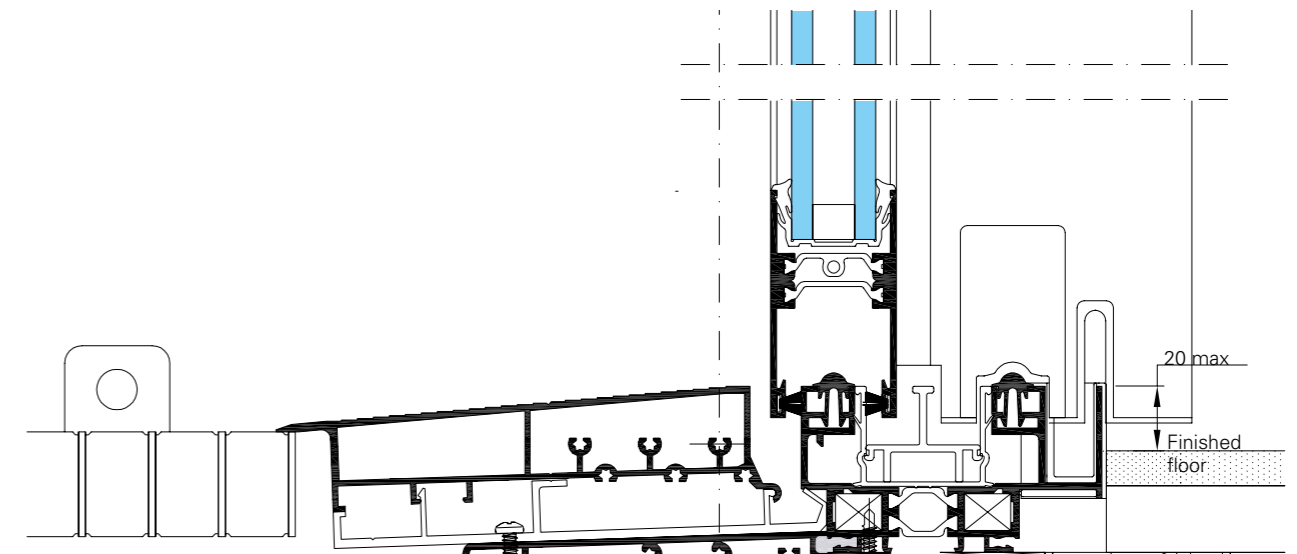

Disabled access threshold on 2 track - 2-leaf (available in 3, 4 tracks and pocket window)

SOLEAL

/ UNIVERSAL SLIDER

SOLEAL
SLIDER

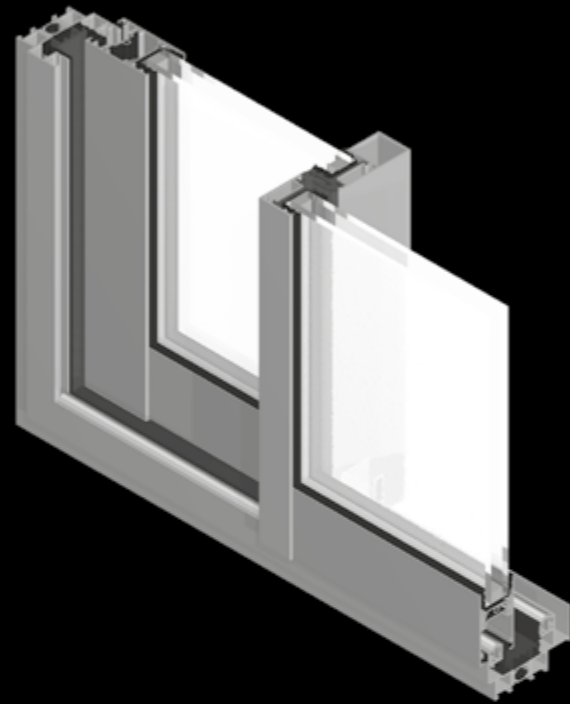

SOLEAL CORNER
SLIDING SYSTEM

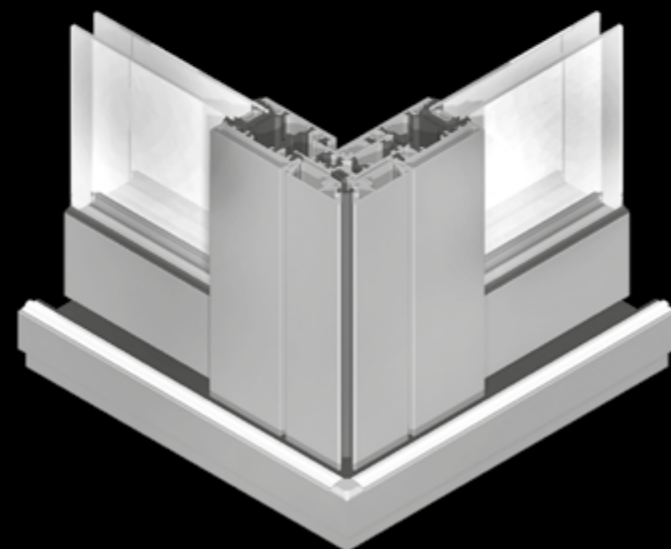

KEY INNOVATIONS AND FEATURES

LARGE SIZES

- The design is suitable for large sizes, taking greater advantage of available daylight
- Sizes up to W 4,3 m x H 2,6 m with high inertia mullions in a 2-leaf frame with a maximum weight of 200 kg per leaf

THERMAL, WEATHER AND ACOUSTIC PERFORMANCE

- SOLEAL sliders are designed to follow changes in the market: local standards, air permeability criteria for low consumption buildings, and acoustic requirements

MULTIPLE APPLICATIONS

- 2, 3 and 4 tracks
- From single-track sliding-sash pocket window to 3-track pocket window
- From 2- to 4-track internal or external corner solution
- From 2- to 3-track internal or external corner pocket window solution
- Composite frames and pocket windows
- Special frame for direct surface fitting to existing joinery
- Cladding (flashings, sills and architraves) as for SOLEAL doors and windows

TWO OPENING FRAME VERSIONS

- Flat faced 24, 26 and 28 mm glazing
- Wider channel for 30 and 32 mm glazing

AESTHETIC DESIGN

- Simple form and slender frames
- Discreet operating mechanism
- Minimalist-style strip reinforcer which may be enhanced with decorative profiles (Technal patent)
- Concealed drainage with invisible water evacuation for all applications

ACCESSIBILITY

- Special ease of access facility for all applications

LOCKING MECHANISMS

- Multiple combinations available with or without 1 to 4-point key-operated locking

SOLEAL

/ 55-MODULE SLIDER

WIDE RANGE

- Fixed frames with 2, 3 and 4 tracks with or without infill channels fitted with 20 mm thermal break
- Special fixed frames
 - Face mounting for renovation applications
 - With integral architrave for new build
 - For continuous strip
 - For integration into composite glazing

WEATHER PERFORMANCE

- Optimised air permeability meeting low consumption building criteria for all applications, both in domestic and commercial buildings
Values obtained: 0.19 m³/(h.m²)* at 4 Pa

*2-leaf slider: dimensions W 3.0 m x H 2.5 m

THERMAL PERFORMANCE

- Optimised heat loss values 55 mm module base version:
U_w up to 1.4 W/m².K, Sw: 0.45 and TLw: 0.59*

* These values are obtained with double glazing rated at 1.0 W/m².K and insulating spacer measuring W 4.3 m x H 2.6 m

SECTIONS

2-LEAF - 2-TRACK

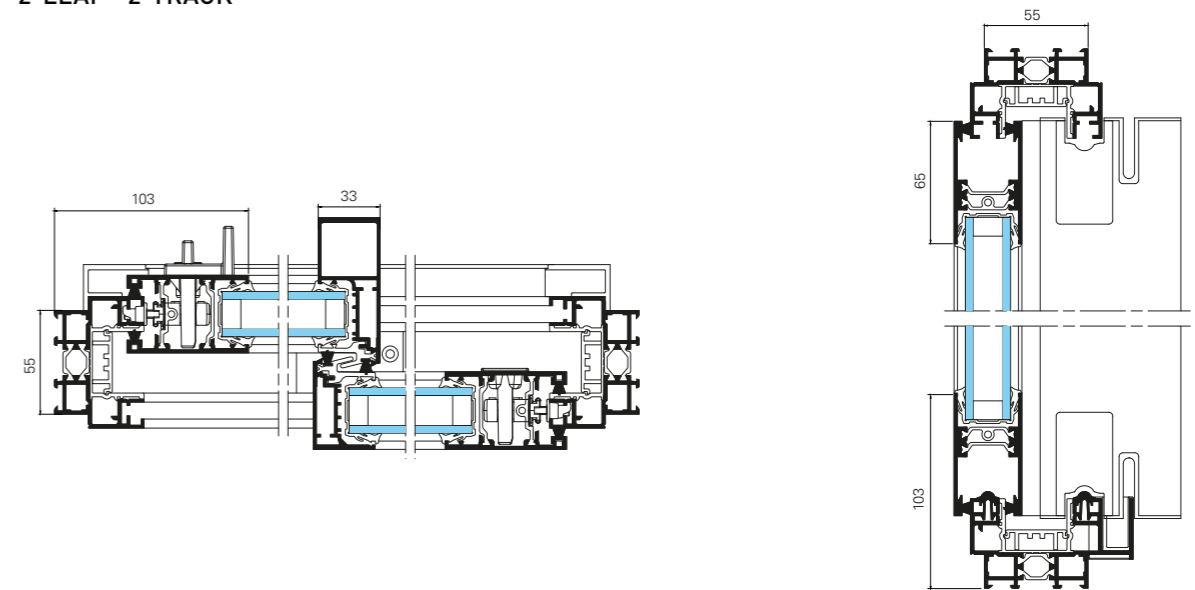

4-LEAF - 2-TRACK

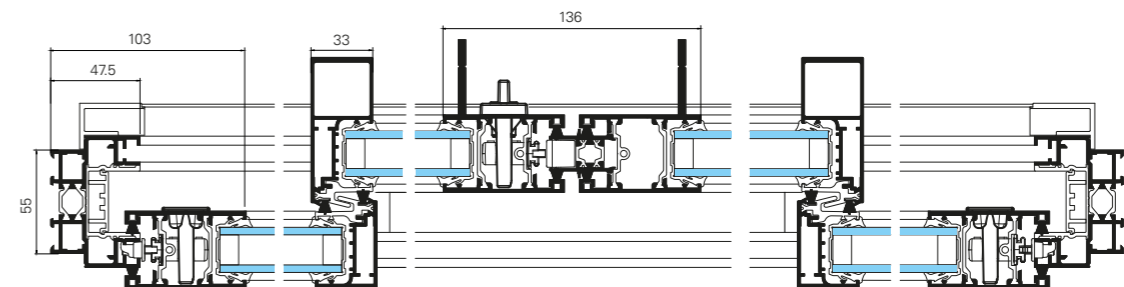

3-LEAF - 3-TRACK

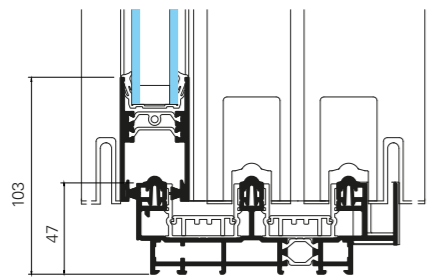
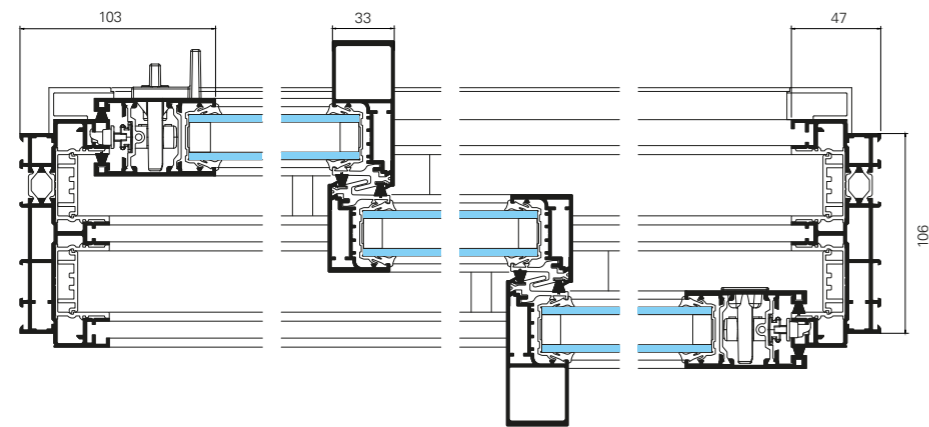

4-LEAF - 4-TRACK

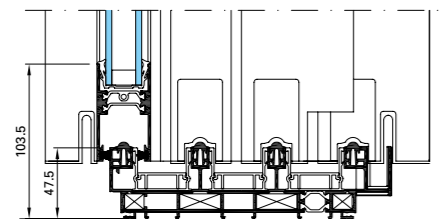
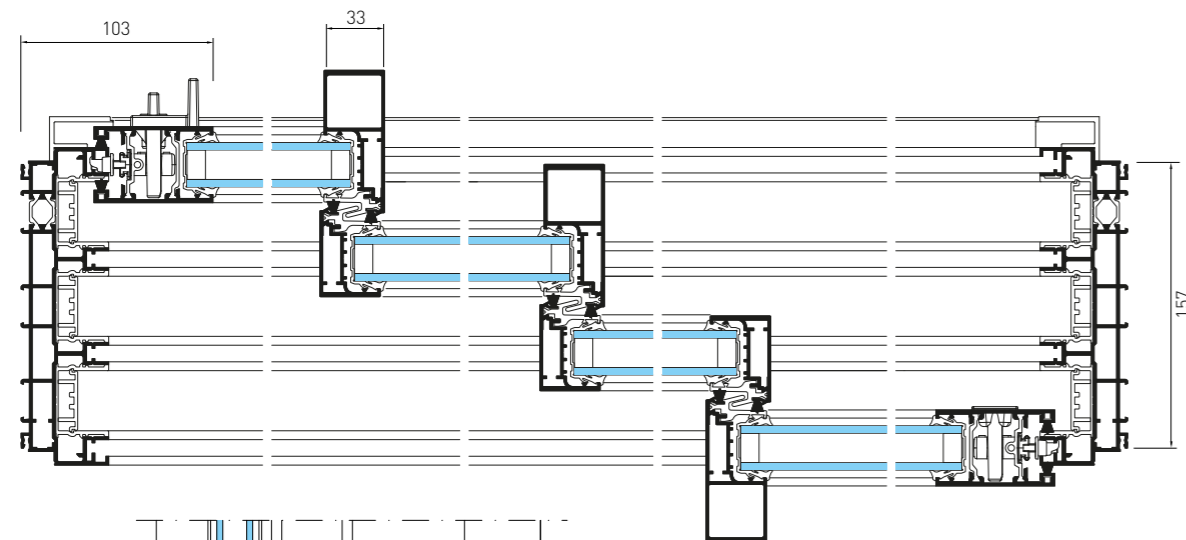

SOLEAL

/ 55-MODULE SLIDER

POCKET WINDOWS

Pocket windows applications are derived from the base frames, to which the internal and external cladding forming the inner partition are added, to create 1-leaf, 2-leaf or 4-leaf frames based on 2 tracks, and 3 leaves on 3 tracks in cases where the cavity is not deep enough.

SOLEAL pocket windows also have the advantage of concealed drainage for all track configurations, along with the lower tracks being adapted to facilitate disabled access.

1-LEAF

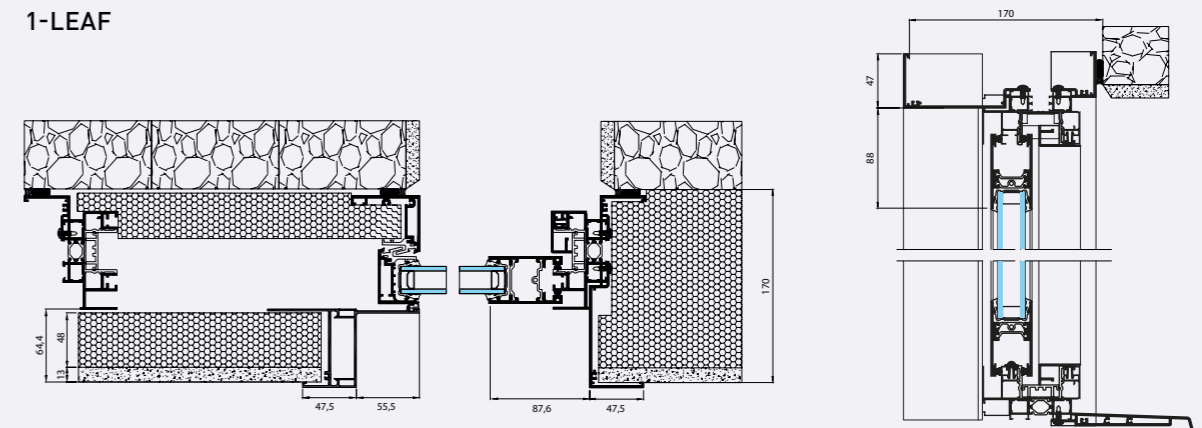

2-LEAF

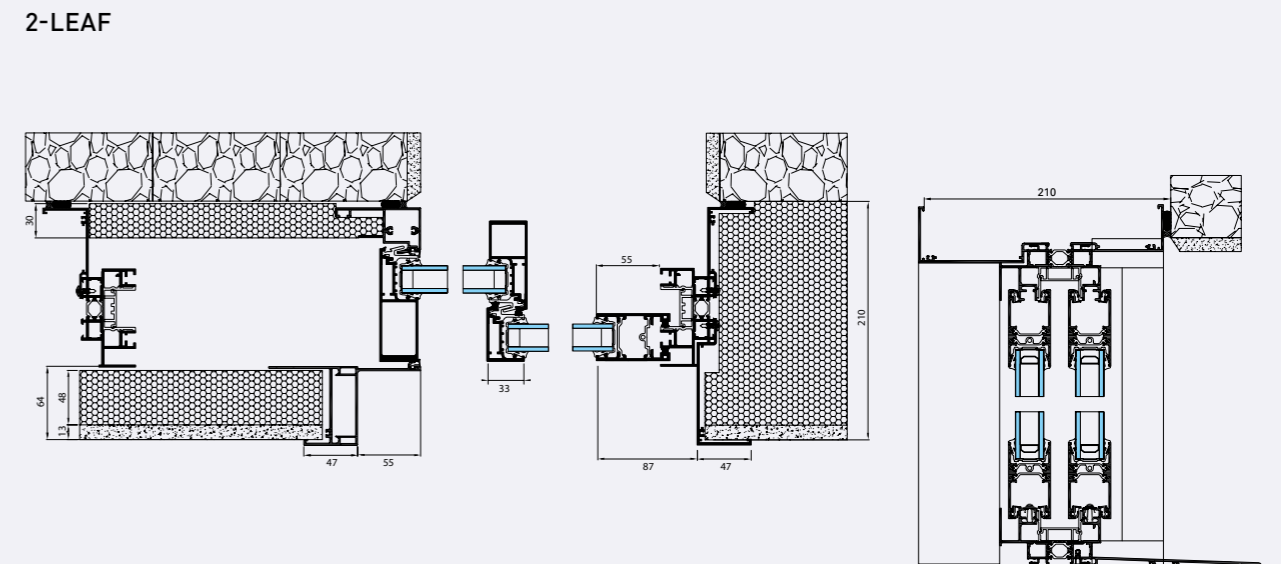

SOLEAL

/ CORNER SLIDING SYSTEM

SOLEAL slider provides external or internal corner solution to design even more original projects.

The reinforced opening sashes create a transparent envelope due to large, full-height openings. Very modern and contemporary, this system gives fine and slender aesthetics.

Pocket window applications are derived from the base frames, to which the internal and external cladding forming the inner partition are added.

APPLICATIONS

- Base frames up to 4-track
- Pocket windows up to 3-track
- Sizes up to H 2.5 x W 6m each leaf, on 3-track.
- Concealed drainage for all track configurations
- Bottom tracks can be adapted to facilitate disabled access

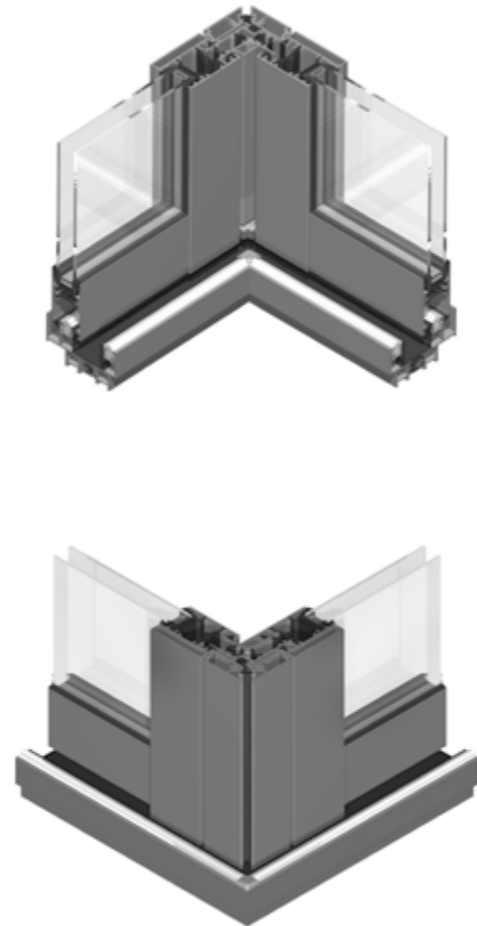

SECTIONS

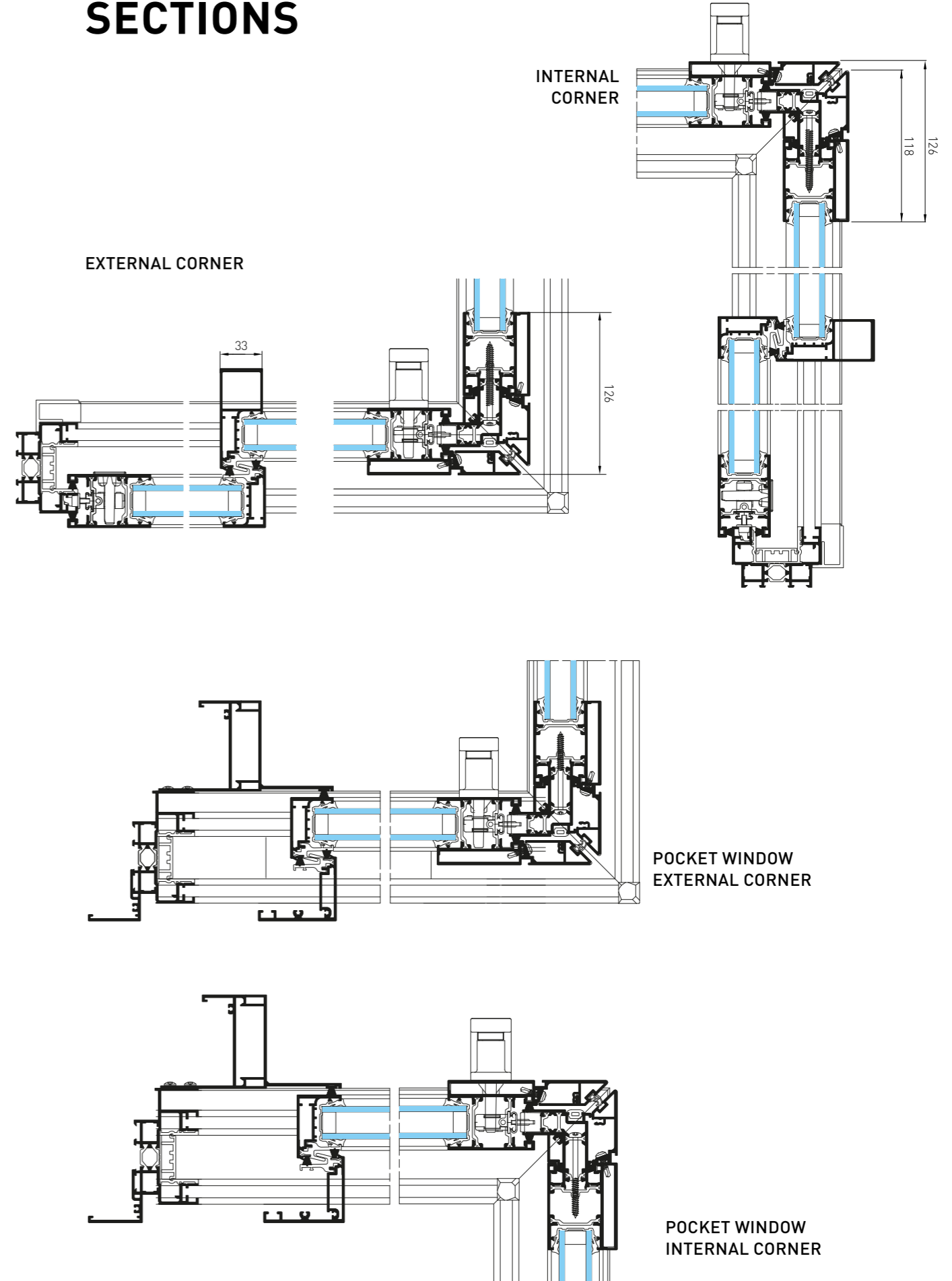

SOLEAL 65

/ UNIVERSAL SLIDER

STRAIGHT-CUT
ASSEMBLY



'MONOBLOC'
VERSION



PERIPHERAL
FIXED FRAME



KEY INNOVATIONS AND FEATURES

3 VERSIONS

- 65 mm peripheral fixed frame for high performances and compatible with all SOLEAL range windows and doors
- 65 mm straight-cut assembly with thin lines of aluminium and exceptional thermal performances
- 65 mm 'monobloc' version of the outer frame which enables large-scale fabrication for new build

LARGE DIMENSIONS

The design is allowing big dimensions for more solar contribution. Dimensions are up to 4.3 m x 2.6 m with high inertia stile in 2 leaves application and maximum weight by leaf going up to 200 kg.

HIGH PERFORMANCES

SOLEAL sliding system 65 mm is thermally efficient thanks to his thermal break of 30 mm and 40 mm going beyond market actual request.

APPLICATIONS

- 2, 3 et 4 rails
- Composite frame
- Specific fixed frame for direct fitting on old joinery
- Cladding (sill, flashing and architrave) common with SOLEAL range, doors and windows

VERSIONS D'OUVRANTS

- Flat faced 24 to 28 mm glazing
- Wider channel for 29 to 32 mm glazing

DESIGN

- Discreet operating mechanism
- Minimalist-style strip reinforcer which may be enhanced with decorative profiles (Technal patent)
- Concealed drainage with invisible water evacuation for all applications

ACCESSIBILITY

Special ease of access facility for all applications

FERMETURES

Multiple combinations available with or without 1 to 4-point key-operated locking

SOLEAL

/ 65 MM SLIDING SYSTEM

SOLEAL 65 MM PERIPHERAL FIXED FRAME

- Minimalist-style strip reinforcer which maybe enhanced with decorative profiles
- Thermal performances:
 $U_w = 1.5 \text{ W/m}^2\cdot\text{K}$, $TL_w = 0.58$ and $Sw = 0.43$
 * ($U_g = 1.0 \text{ W/m}^2\cdot\text{K}$ + Swisspacer stainless still or equivalent) Balcony door 2 leaves peripheral application (L 2.30 m x H 2.18)
- Application
 - 2-leaf window and balcony-door
 - Left and right 3-leaf window and balcony door
 - 4-leaf central meeting stile window and balcony-door

SOLEAL 65 MM STRAIGHT CUT

- High thermal performance, achieved with extra-wide thermal breaks (39 and 42 mm)
- The SOLEAL 65 has narrow sight-lines in this version with lateral sill of 88 mm only, 33 mm on central mullion and 136 mm on 4-leaf central meeting stile
- Thermal performance:
 $U_w = 1.4 \text{ W/m}^2\cdot\text{K}$, $Sw = 0.42$, $PL_w = 0.58^*$
 ($U_g = 1.0 \text{ W/m}^2$ with insulating insert)
 Dimensions = W 2.3 x H 2.18 m
- Application
 - 2-leaf window and balcony-door
 - Left and right 3-leaf window and balconydoor
 - 4-leaf central meeting stile window and balcony-door

SOLEAL 65 MM MONOBLOC VERSION

- SOLEAL 65 also has a 'monobloc' version of the outer frame in 2 rails with 3 different tightness possibilities 120 mm, 140 mm and 160 mm which enables large-scale fabrication for new build.



SOLEAL 65 mm straight cut

SECTIONS

2-LEAF STRAIGHT CUT FRAME

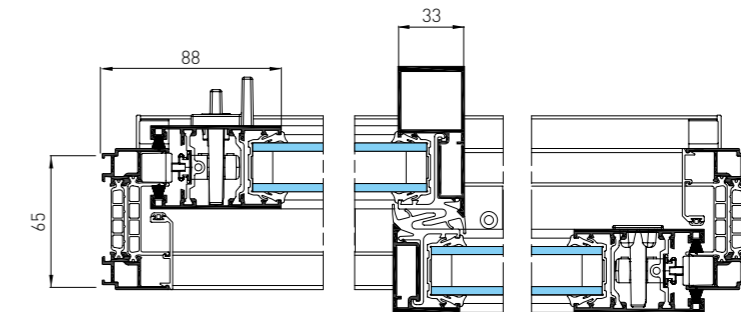
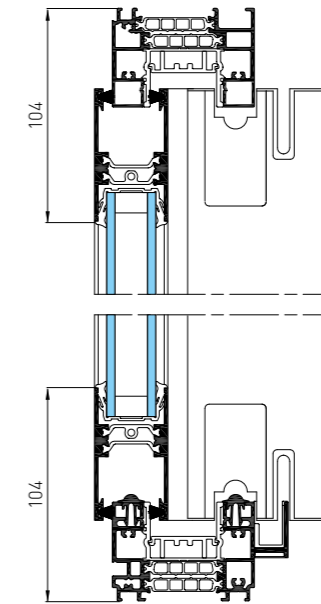

SECTIONS

2-LEAVES 'MONOBLOC'

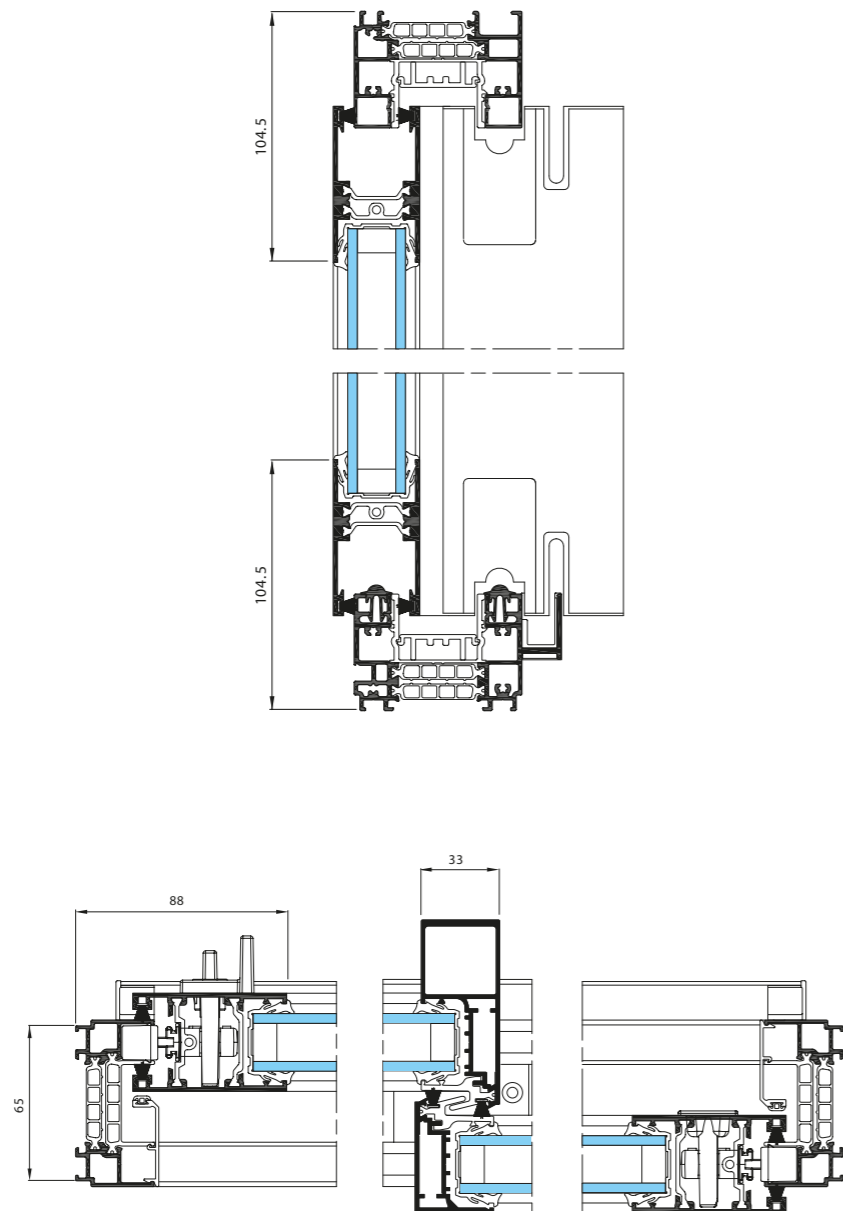

2-LEAVES 'MONOBLOC'

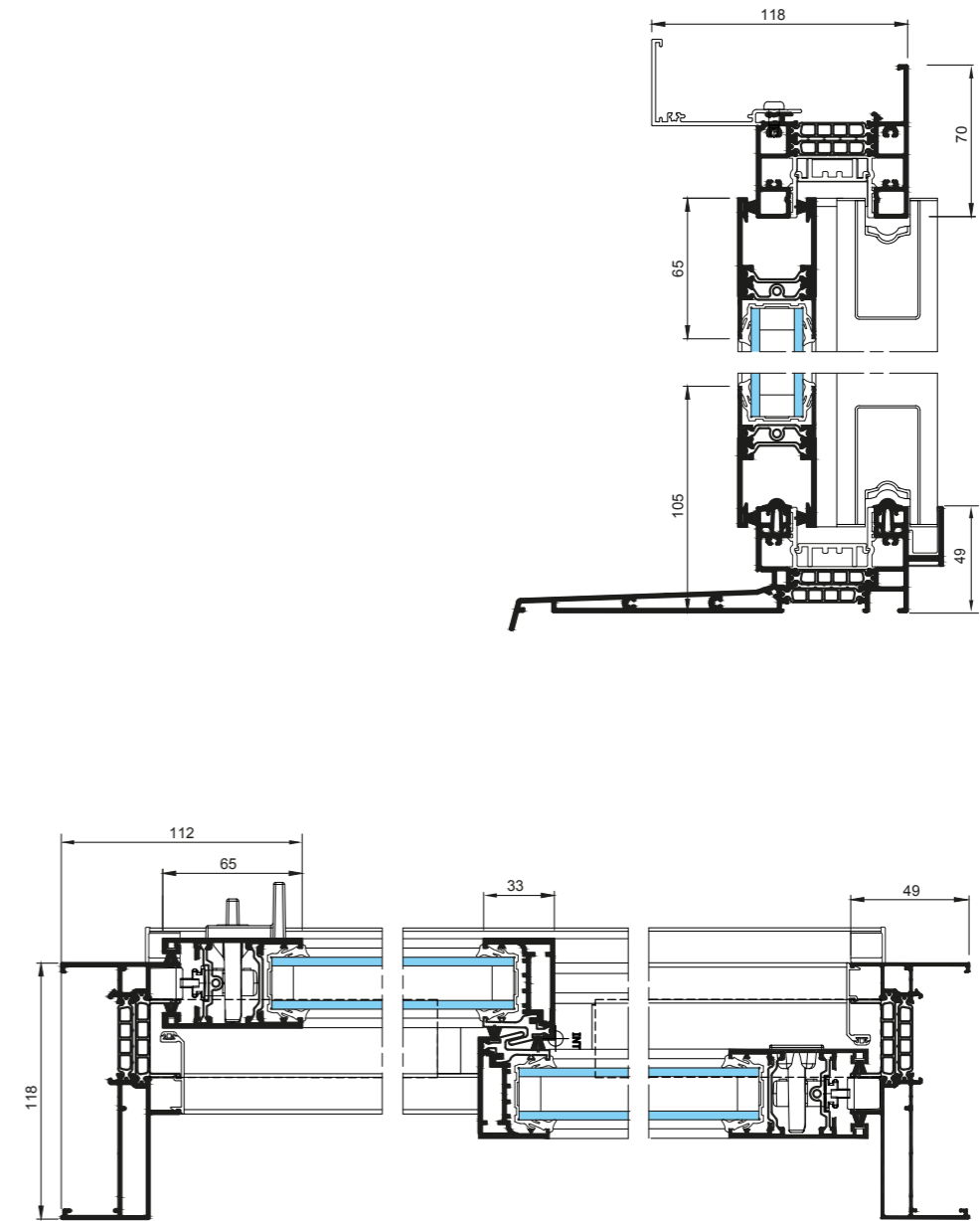



APPLICATIONS

/ 55 MM SLIDING SYSTEM

All of these applications are available with concealed drainage.
 All patio door applications may be supplied with a disabled access threshold

BASE CHASSIS

2 TRACKS

2-leaf - 2 tracks

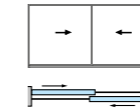

Integrated composite
2-leaf

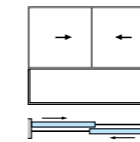

3-leaf joined
2 tracks

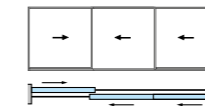

3-leaf independent
2 tracks

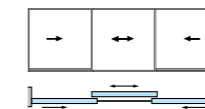

POCKET WINDOW CHASSIS

SINGLE TRACK

Single-track
leaf

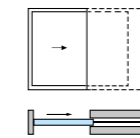

4-leaf
2 tracks

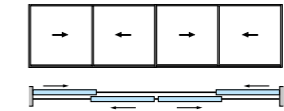

3 TRACKS

3-leaf
3 tracks

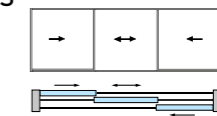

6-leaf
3 tracks

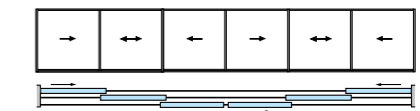

4 TRACKS

4-leaf
4 tracks

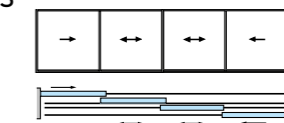

8-leaf
4 tracks

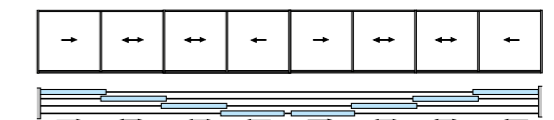

2 TRACKS

2-leaf
2 tracks

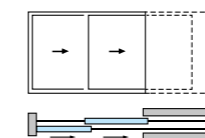

4-leaf
2 tracks

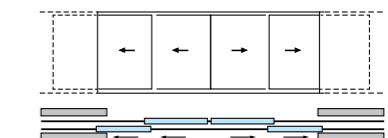

3 TRACKS

3-leaf
3 tracks

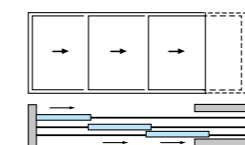

APPLICATIONS

/ CORNER SLIDER

BASE FRAMES

External corner

Internal corner

POCKET WINDOW CHASSIS

External corner

Internal corner

SINGLE TRACK

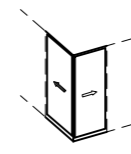

2 x 1 leaf

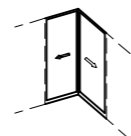

2 x 1 leaf

2-TRACK

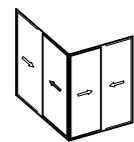

2 x 2 leaves

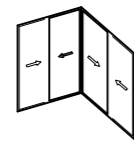

2 x 2 leaves

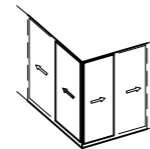

2 x 2 leaves

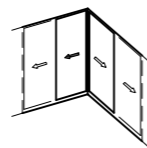

2 x 2 leaves

3-TRACK

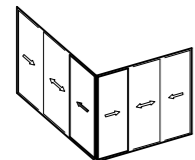

2 x 3 leaves

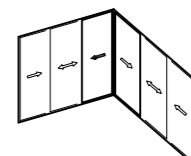

2 x 3 leaves

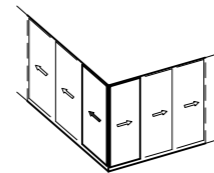

2 x 3 leaves

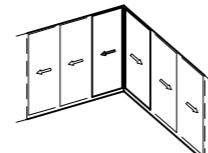

2 x 3 leaves

4-TRACK

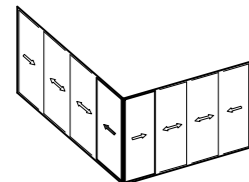

2 x 4 leaves

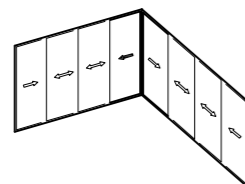

2 x 4 leaves

APPLICATIONS

/ 65 MM MONOBLOC

2-TRACK

2-leaf

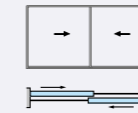

3-leaf independent
2 tracks

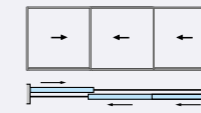

3-leaf independent

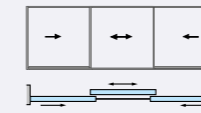

4-leaf

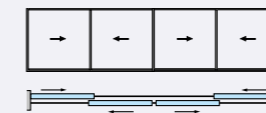

INSTALLATION OPTIONS

EXTERNAL INSULATION INSTALLATION

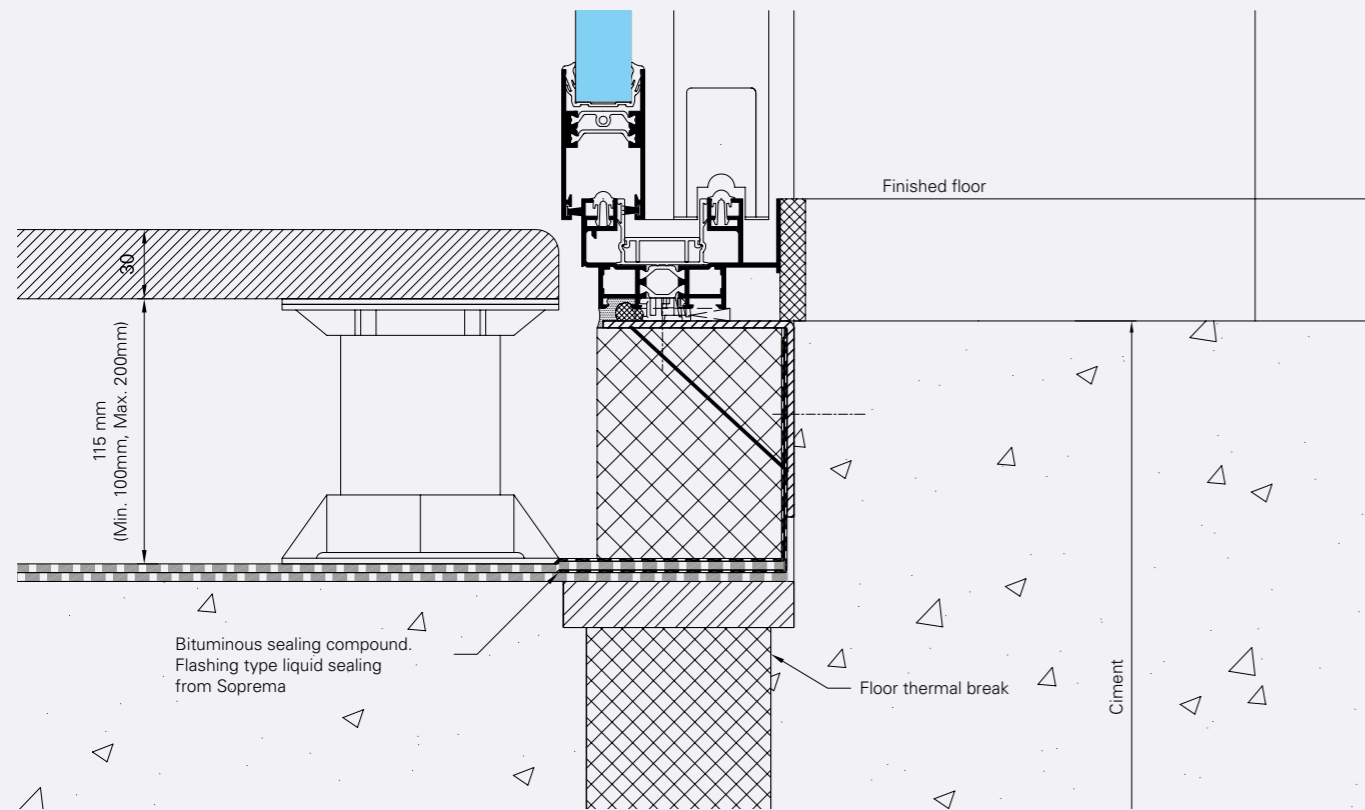
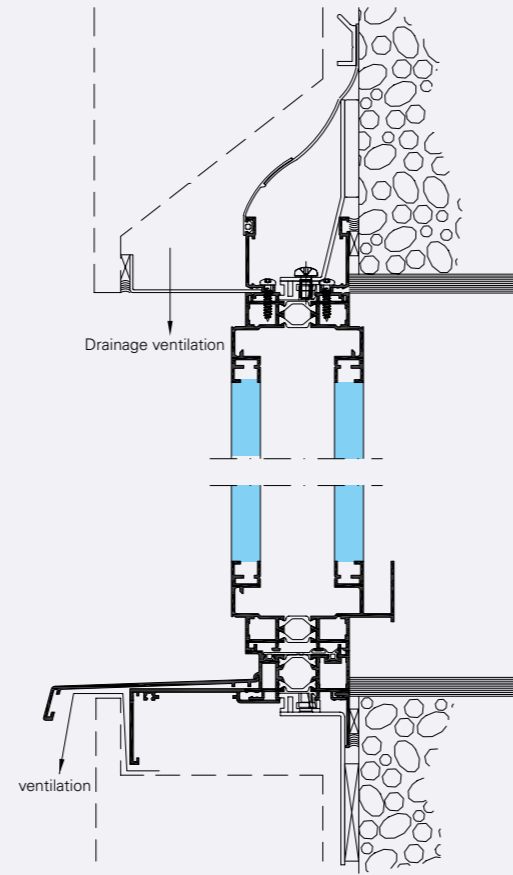

INTERNAL INSTALLATION

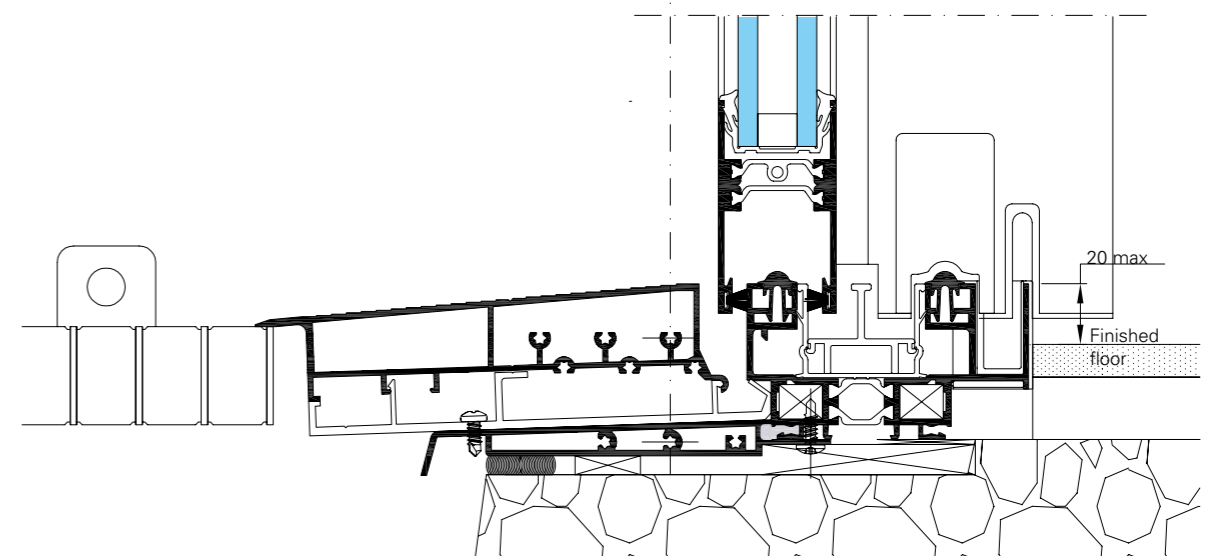
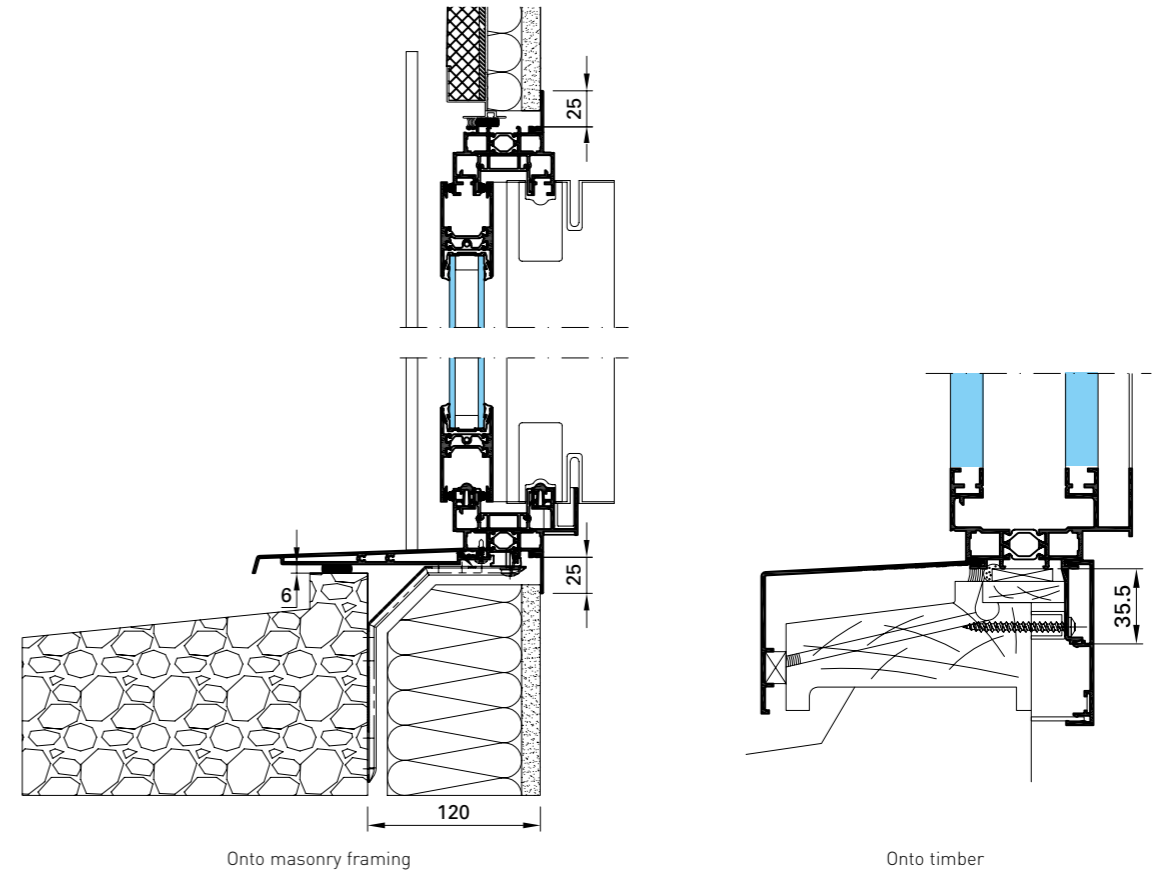

Disabled access threshold on 2 tracks - 2-leaf (available in 3, 4 tracks and pocket window)

PERFORMANCE

/ 55 MM SLIDING SYSTEM

Whether for residential or office buildings, the RT 2012 French thermal regulations aim to set a maximum energy consumption level for new buildings.

These regulations do not impose a minimum requirement for glazing but Technal's objective is to support architects in this new objective.

The SOLEAL slider therefore helps to preserve the permeability of the building envelope due to its excellent Q100* and Q4 values.

*Q100 represents leakage from the frame at 100 Pascals. For Low Energy Consumption Buildings, Q100 must not exceed 5.1 for single family housing or 8.5 for blocks of flats (in m³/hr/m²).

WEATHER PERFORMANCE AIR (A), WATER (E), WIND (V)						
Type	Dimensions W x H (m)	Air permeability	Water tightness	Wind resistance	Q100	Q4
SOLEAL 55						
2 tracks – 2-leaf	3 x 2.5	Class 4	Class 6A	Class B2	1.65	0.19
3 tracks – 3-leaf	3.5 x 2.348	Class 4	Class 7A	Class C2	2.5	0.29
2 tracks – 4-leaf, central meeting stile	3.5 x 2.348	Class 4	Class 6A	Class C2	1.78	0.21
2 tracks – 2-leaf, disabled access threshold	3 x 2.5	Class 4	Class 7A	Class B2	2.04	0.24
2 tracks – 2-leaf integrated SOLEAL casement	1.4 x 2.5 with bottom fixed light at 1 m	Class 4	Class 5A	Class C2	2.16	0.25

AIR PERMEABILITY FOR LOW CONSUMPTION BUILDINGS (average per m2 including walls)		
	Q4 Pa Max	equivalent to Q100 Pa Max
One family dwelling m ³ /(h.m ²)	0.6	5.1
Block of flats m ³ /(h.m ²)	1	8.5

Note : Q = Q100 x (P/100)^{2/3}
 Q100 = Leakage flow at 100 Pa / P = Pressure Pa / Q = Leakage flow at Pa

ACOUSTIC PERFORMANCE								
Type	Description	Dimensions W x H (m)	Glazing reduction (dB)			Window reduction (dB)		
			Rw	RA	RA, Tr	Rw	RA	RA, Tr
Window								
2 tracks – 2-leaf	4(16)8	W 1.85 x H 1.48	36	34	31	33	32	30
2 tracks – 2-leaf	6(16)10	W 1.85 x H 1.48	37	36	34	36	35	34
2 tracks – 2-leaf	44.1s(14)10	W 1.85 x H 1.48	42	41	37	37	37	35
Patio-door								
2 tracks – 2-leaf	4(16)8	W 2.35 x H 2.18	36	34	31	35	34	31
2 tracks – 2-leaf	6(16)10	W 2.35 x H 2.18	37	36	34	36	34	32
2 tracks – 2-leaf	44.1s(14)10	W 2.35 x H 2.18	42	41	37	36	35	34

In accordance with EN 14351-1, these window performances are valid for:
 - Rw +Ctr (for index RA, tr) glazing greater than or equal to the values of the glass tested
 - corrections - 1 dB for leaf surface + 50% to + 100% / - 2 dB for + 100% to + 150% / - 3 dB for + 150% to + 200%

THERMAL PERFORMANCE					
Type	Dimensions W x H (m)		Uw with Ug =1.1	Uw with Ug=1.1 warm edge*	Uw with Ug=1.0 warm edge*
SOLEAL 55					
2 tracks – 2-leaf	2.3 x 2.18	Uw	1.7	1.6	1.5
		Sw	0.52	0.52	0.42
		TLw	0.58	0.58	0.51
2 tracks – 4-leaf	4.6 x 2.18	Uw	1.6	1.5	1.4
		Sw	0.53	0.53	0.42
		TLw	0.66	0.66	0.59
3 tracks – 3-leaf	3.45 x 2.18	Uw	1.8	1.7	1.6
		Sw	0.53	0.53	0.43
		TLw	0.67	0.67	0.59
3 tracks – 6-leaf	6.5 x 2.18	Uw	1.8	1.7	1.6
		Sw	0.53	0.53	0.43
		TLw	0.67	0.67	0.60
4 tracks – 4-leaf	4.6 x 2.18	Uw	1.8	1.7	1.7
		Sw	0.54	0.54	0.43
		TLw	0.68	0.68	0.60

* Swisspacer stainless steel or equivalent

PERFORMANCE

/ 65 MM SLIDING SYSTEM

THERMAL PERFORMANCE					
Type	Dimensions W x H en m		With Ug = 1.1	With Ug = 1.1 warm edge*	With Ug = 1.0 warm edge*
SOLEAL 65 STRAIGHT CUT					
2 tracks – 2-leaf	2.3 x 2.18	Uw	1.6	1.5	1.4
		TLw	0.66	0.66	0.58
		Sw	0.53	0.53	0.42
2 tracks – 4-leaf	4.6 x 2.18	Uw	1.6	1.5	1.4
		TLw	0.66	0.66	0.58
		Sw	0.53	0.53	0.42
SOLEAL 65 PERIPHERAL FIXED FRAME					
2 tracks – 2-leaf	2.3 x 2.18	Uw	1.7	1.6	1.5
		TLw	0.66	0.66	0.58
		Sw	0.54	0.54	0.43
2 tracks – 4-leaf	4.6 x 2.18	Uw	1.6	1.5	1.5
		TLw	0.68	0.68	0.59
		Sw	0.55	0.55	0.44

* Swisspacer inox ou équivalent

WEATHER PERFORMANCE AIR (A), WATER (E), WIND (V)						
Type	Dimensions L x H en m	Air permeability	Water tightness	Wind resistance	Q100	Q4
SOLEAL 65 STRAIGHT CUT						
2 tracks – 2-leaf	3 x 2.5	Class 4	Class 6A	Class B2	3.24	0.38
Balcony door 2 tracks – 2-leaf with disable threshold	3 x 2.5	Class 4	Class 5A	Class B2	1.88	0.22
SOLEAL 65 PERIPHERAL FIXED FRAME						
Window 2 tracks – 2-leaf	3 x 2.5	Class 3	Class 7A	Class B2	0.29	2.52
Balcony door 2 tracks – 2-leaf with disable threshold	3 x 2.5	Class 4	Class 5A	Class B2	0.26	2.25

MATERIALS AND COMPONENTS

As with all Technal systems, only high quality materials and components are used to reduce maintenance and guarantee long-term performance.

- The aluminium profiles are extruded from alloys 6060 Building compliant with EN 12020, EN 573-3, EN 515 and EN 775-1 to 9.
- Fittings are cast from EN 12844 compliant Zamak 5.
- All seals EPDM or TPE (Thermo Plastic Elastomer).
- The polyamide thermal breaks are extruded from pA6-6 (0.25 FV).
- Screws are made of stainless steel.

FINISHES AND COLOURS

A wide range of finishes is available to meet the requirements of individual projects, to enhance existing buildings and to offer increased design choice to architects and designers:

- Natural anodised in compliance with EN 123731: 2001.
- Polyester coating finishes in an extensive range of colours, in compliance with QUALICOAT instructions.
- SOLEAL is also available in painted finishes in colours exclusive to Technal for a stylish and modern appearance.

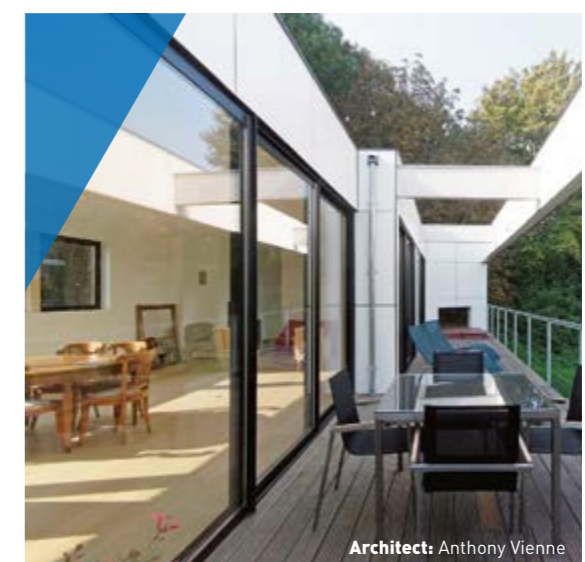



IMAGINE WHAT'S NEXT

270, rue Léon-Joulin
BP 63709 - 31037 Toulouse cedex 1
Tél. 05 61 31 28 28 - www.technal.com



By  Hydro